

DIY: HOW TO CLEAN YOUR WATER DISPENSER

500 SERIES
pure water dispenser

Your water dispenser exterior should be thoroughly cleaned at least twice a year, and your SmartFlo™ water cartridge replaced every 12 months. If you do not have a replacement cartridge handy, you can order one [here](#) and it will be delivered directly to you. Your replacement kit will include a SmartFlo™ cartridge, bottle adaptor, lid key and plug for the bottle tube:

Before you start cleaning, wash your hands thoroughly with soap and water for at least 20 seconds.

 **TIP:** The best time to replace your water cartridge is when the existing water bottle is empty.

WHAT YOU'LL NEED:

- SmartFlo™ replacement cartridge (if replacing)
- 70% rubbing alcohol or disinfecting wipes
- Clean cloth or soft brush
- Disposable non-latex gloves
- Bucket
- Heat-resistant container to fit under spigots
- Towels to absorb any water spills

If not replacing the SmartFlo™ cartridge skip to steps 16-18

 **WARNING:** Always use caution when handling hot water.

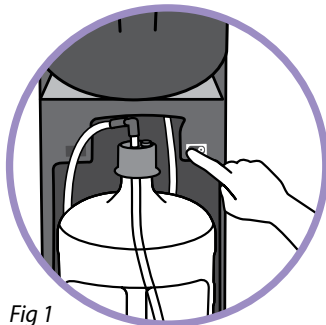

Fig 1

1. Slide the dispenser door up and turn off the hot tank heater switch (Fig 1). Let the unit stand for one hour before cleaning to allow the hot tank to cool.

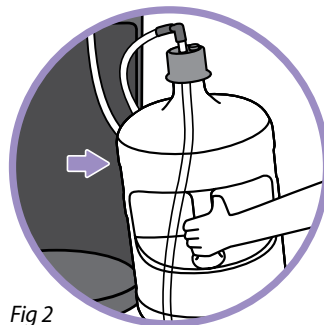

Fig 2

2. Remove the empty water bottle (Fig 2). Wipe interior cabinet with 70% rubbing alcohol or disinfecting wipes.

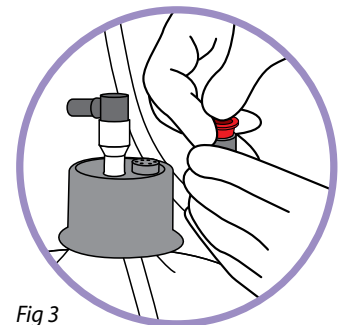

Fig 3

3. Unplug the bottle tube connected to the neck of the water bottle. Plug the bottle tube using the red plug provided in the SmartFlo™ replacement kit (Fig 3).

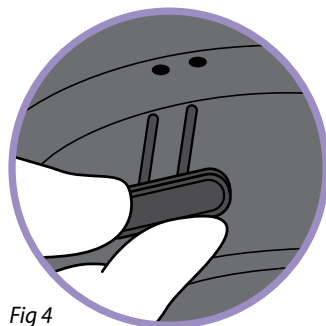

Fig 4

4. Close dispenser door. Place a glass or other container below the water faucets to catch any drips.
5. Remove cup holders, if applicable. Open the dispenser lid using the key provided in the replacement kit (Fig 4).

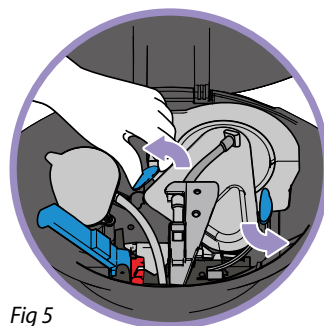

Fig 5

6. Remove the SmartFlo™ cartridge and bottle tube by unlatching the blue locking arm and rotating the two blue knobs to the open position (Fig 5).

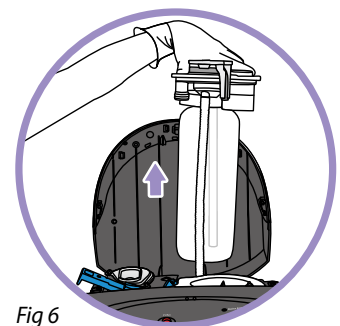



Fig 6

7. Pull up on the SmartFlo™ water cartridge (Fig 6). Do not squeeze the water reservoir as water could leak out.

 **TIP:** Have a bucket nearby to dispose of the used SmartFlo™ cartridge and bottle tube, which will contain water.

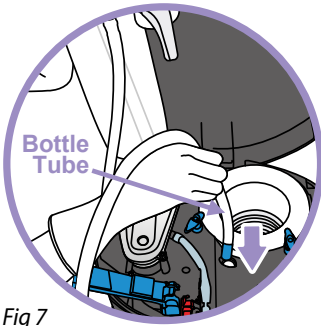

Fig 7

- Wearing gloves, feed the new bottle tube through the hole indicated (Fig 7).

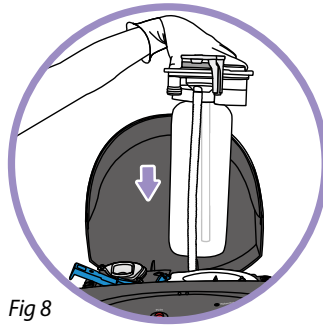

Fig 8

- Insert the new SmartFlo™ cartridge and secure into place by pressing down (Fig 8).

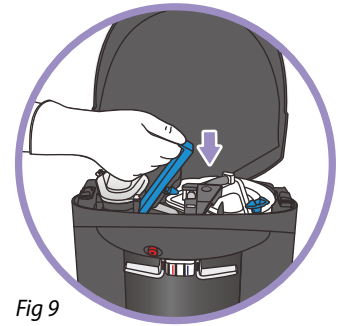

Fig 9

- Rotate the blue knobs to the closed position. Close and latch the blue locking arm (Fig 9).
- Close the dispenser lid by pushing down to lock into place.

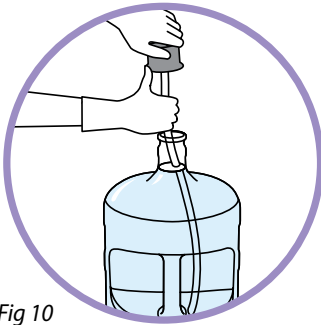

Fig 10

- Wearing gloves, carefully unpack the new bottle adaptor. Pull the adaptor tube to straighten (Fig 10) and insert it into a new water bottle.

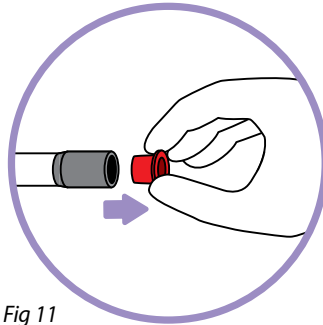

Fig 11

- Feed the tube into the water bottle until it reaches the bottom.

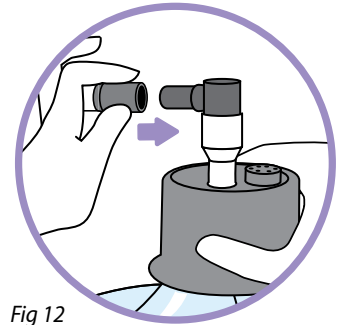

Fig 12

- Remove the red protective cap from the bottle tube (Fig 11). Install it into the bottle adaptor (Fig 12).
- Slide water bottle into the cabinet and close the door.
- Clean spigots, bottle receptacle and cabinet with 70% rubbing alcohol or disinfecting wipes. Vacuum or wipe the grill on the back of the dispenser to remove any dust.



TIP: The dispenser exterior should be cleaned every 6 months.

- Clean the drip tray and grill by emptying the tray and cleaning the tray and grill with dishwashing soap or by placing them on the top rack of the dishwasher (Fig 13).



TIP: The drip tray and grill should be cleaned monthly.

- Wipe down the dispenser and the surrounding area to dry any water spills.
- Prime the dispenser to fill the reservoir by holding down the cold water spigot for 1 minute, or until water flows continuously. Repeat with the hot water spigot until water flows continuously. **Turn on the hot tank switch.**



Fig 13

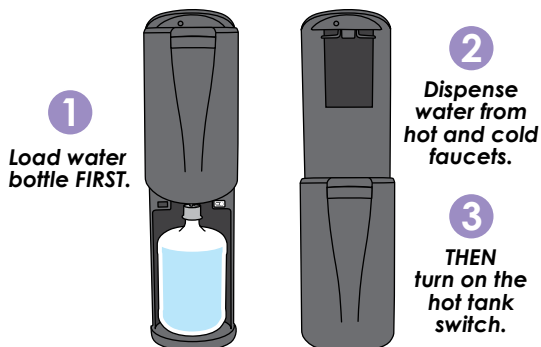

WARNING: Dispense water through the hot and cold spigots before turning on the hot tank switch. Failure to follow proper installation instructions may cause damage to water dispenser.